

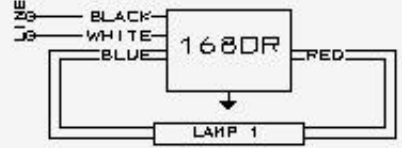



France Ballast Labels

As of 07/27/2004

<p>CATALOG NO. 168DR</p> <p>120 Volts 60 Hz.</p> <p>MAX. LINE: .66 AMPS OUTPUT: 390 VOLTS HIGH POWER FACTOR</p> 	<p>FRANCE A SCOTT FETZER COMPANY</p> <p>FLUORESCENT LAMP BALLAST NON-FLASHING OUTDOOR TYPE 2 1 LAMP - 2 TO 6 FEET</p> <p>FOR ANY 1 LAMP COMBINATION OF 800 mA T-12 H.O. RAPID START LAMPS. TOTAL FOOTAGE OF LAMP MUST NOT EXCEED 6 FT. NOR BE LESS THAN 2 FT. POWER FACTOR ABOVE 80% FOR LAMP FOOTAGE LESS THAN 4 FEET.</p> <p>FAIRVIEW, TN 37062 MADE IN USA</p>	<p>DANGER HIGH VOLTAGE 390 OUTPUT VOLTS OPEN CIRCUIT OR TO GROUND. DANGER HAUTE TENSION</p>  <p>NO PCB'S AUTO RESET THERMALLY PROTECTED CLASS P</p> <p>12308</p>
--	--	--

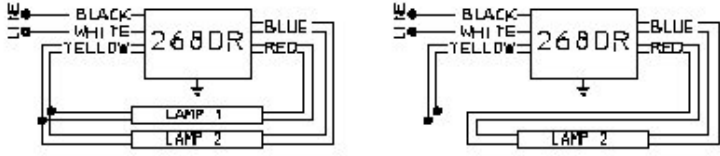
<p>CATALOG NO. 268DR</p> <p>120 Volts 60 Hz.</p> <p>MAX. LINE: 1.2 AMPS OUTPUT: 500 VOLTS HIGH POWER FACTOR</p> 	<p>FRANCE A SCOTT FETZER COMPANY</p> <p>FLUORESCENT LAMP BALLAST NON-FLASHING OUTDOOR TYPE 2 1 OR 2 LAMPS - 4 TO 12 FEET</p> <p>FOR ANY 1 OR 2 LAMP COMBINATION OF 800 mA T-12 H.O. RAPID START LAMPS. TOTAL FOOTAGE OF ALL LAMPS MUST NOT EXCEED 12 FT. NOR BE LESS THAN 4 FT. POWER FACTOR ABOVE 85% FOR LAMP FOOTAGE LESS THAN 6 FEET.</p> <p>FAIRVIEW, TN 37062 MADE IN USA</p>	<p>DANGER HIGH VOLTAGE 500 OUTPUT VOLTS OPEN CIRCUIT OR TO GROUND. DANGER HAUTE TENSION</p>  <p>INSULATE EACH UNUSED LEAD FROM GROUND AND ALL OTHER LEADS. MOUNT LAMPS WITHIN ONE INCH OF GROUNDED METAL STARTING AID. MIN STARTING TEMP. -20°F (-30°C).</p> <p>GROUND BALLAST CASE CAISSE DU TRANSFORMATEUR MIS A TERRE</p> <p>NO PCB'S AUTO RESET THERMALLY PROTECTED CLASS P</p> <p>12365</p>
---	--	--

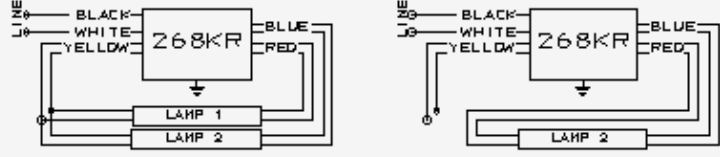
<p>CATALOG NO. 268KR</p> <p>277 Volts 60 Hz.</p> <p>MAX. LINE: .55 AMPS OUTPUT: 500 VOLTS HIGH POWER FACTOR</p> 	<p>FRANCE A SCOTT FETZER COMPANY</p> <p>FLUORESCENT LAMP BALLAST NON-FLASHING OUTDOOR TYPE 2 1 OR 2 LAMPS - 4 TO 12 FEET</p> <p>FOR ANY 1 OR 2 LAMP COMBINATION OF 800 mA T-12 H.O. RAPID START LAMPS. TOTAL FOOTAGE OF ALL LAMPS MUST NOT EXCEED 12 FT. NOR BE LESS THAN 4 FT. POWER FACTOR ABOVE 80% FOR LAMP FOOTAGE LESS THAN 6 FEET.</p> <p>FAIRVIEW, TN 37062 MADE IN USA</p>	<p>DANGER HIGH VOLTAGE 500 OUTPUT VOLTS OPEN CIRCUIT OR TO GROUND. DANGER HAUTE TENSION</p>  <p>INSULATE EACH UNUSED LEAD FROM GROUND AND ALL OTHER LEADS. MOUNT LAMPS WITHIN ONE INCH OF GROUNDED METAL STARTING AID. MIN STARTING TEMP. -20°F (-30°C).</p> <p>GROUND BALLAST CASE CAISSE DU TRANSFORMATEUR MIS A TERRE</p> <p>NO PCB'S AUTO RESET THERMALLY PROTECTED CLASS P</p> <p>12359</p>
--	--	--

France Ballast Labels

As of 07/27/2004

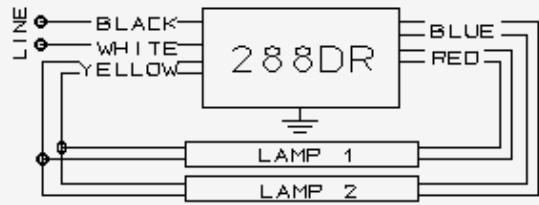
<p>CATALOG NO. 288DR</p> <p>120 Volts 60 Hz.</p> <p>MAX. LINE: 1.80 AMPS OUTPUT: 530 VOLTS HIGH POWER FACTOR</p> 	<p>FRANCE</p> <p>A SCOTT FETZER COMPANY</p> <p>FLUORESCENT LAMP BALLAST NON-FLASHING OUTDOOR TYPE 2 2 LAMPS - 8 TO 16 FEET</p> <p>FOR ANY 2 LAMP COMBINATION OF 800 mA T-12 H.O. RAPID START LAMPS. TOTAL FOOTAGE OF BOTH LAMPS MUST NOT EXCEED 16 FT. NOR BE LESS THAN 8 FT.</p> <p>FAIRVIEW, TN 37062 MADE IN U.S.A.</p>	<p>DANGER HIGH VOLTAGE 530 OUTPUT VOLTS OPEN CIRCUIT OR TO GROUND DANGER HAUTE TENSION</p>  <p>MOUNT LAMPS WITHIN ONE INCH OF GROUNDED METAL STARTING AID. MIN. STARTING TEMP. -20°F (-30°C).</p> <p>GROUND BALLAST CASE CAISSE DU TRANSFORMATEUR MIS A TERRE</p> <p>NO PCB'S AUTO RESET THERMALLY PROTECTED</p> <p>CLASS P</p> <p>12307</p>
---	--	--

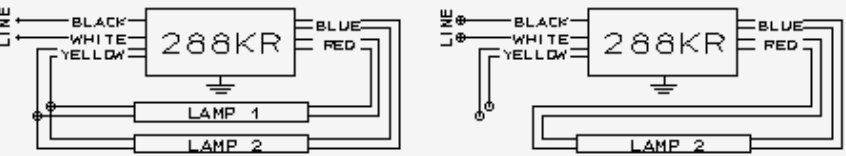
<p>CATALOG NO. 288KR</p> <p>277 Volts 60 Hz.</p> <p>MAX. LINE: 0.77 AMPS OUTPUT: 550 VOLTS HIGH POWER FACTOR</p> 	<p>FRANCE</p> <p>A SCOTT FETZER COMPANY</p> <p>FLUORESCENT LAMP BALLAST NON-FLASHING OUTDOOR TYPE 2 1 OR 2 LAMPS - 8 TO 16 FEET</p> <p>FOR ANY 1 OR 2 LAMP COMBINATION OF 800 mA T-12 H.O. RAPID START LAMPS. TOTAL FOOTAGE OF BOTH LAMPS MUST NOT EXCEED 16 FT. NOR BE LESS THAN 8 FT.</p> <p>FAIRVIEW, TN 37062 MADE IN U.S.A.</p>	<p>DANGER HIGH VOLTAGE 550 OUTPUT VOLTS OPEN CIRCUIT OR TO GROUND. DANGER HAUTE TENSION</p>  <p>INSULATE EACH UNUSED LEAD FROM GROUND AND ALL OTHER LEADS. MOUNT LAMPS WITHIN ONE INCH OF GROUNDED METAL STARTING AID. MIN. STARTING TEMP. -20°F (-30°C).</p> <p>GROUND BALLAST CASE CAISSE DU TRANSFORMATEUR MIS A TERRE</p> <p>NO PCB'S AUTO RESET THERMALLY PROTECTED</p> <p>CLASS P</p> <p>12311</p>
---	--	--

France Ballast Labels

As of 07/27/2004

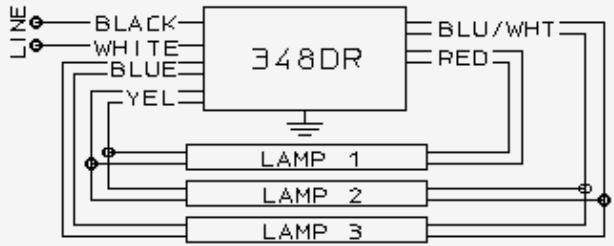
<p>CATALOG NO. 348DR</p> <p>120 Volts 60 Hz.</p> <p>MAX. LINE 1.4 AMPS OUTPUT 500 VOLTS HIGH POWER FACTOR</p> <p> LISTED 820G</p>	<p>FRANCE</p> <p>A SCOTT FETZER COMPANY</p> <p>FLUORESCENT LAMP BALLAST NON-FLASHING OUTDOOR TYPE 2 3 LAMPS - 6 TO 12 FEET</p> <p>FOR ANY 3 LAMP COMBINATION OF 800 mA T-12 H.O. RAPID START LAMPS. TOTAL FOOTAGE OF ALL LAMPS MUST NOT EXCEED 12 FT. NOR BE LESS THAN 6 FT.</p> <p>FAIRVIEW, TN 37062 MADE IN U.S.A.</p>	<p>DANGER HIGH VOLTAGE 500 OUTPUT VOLTS OPEN CIRCUIT OR TO GROUND DANGER HAUTE TENSION</p>  <p>MOUNT LAMPS WITHIN ONE INCH OF GROUNDED METAL STARTING AID. MIN. STARTING TEMP. -20°F (-30°C).</p> <p>GROUND BALLAST CASE</p> <p>NO PCB'S AUTO RESET THERMALLY PROTECTED CLASS P</p> <p>CAISSE DU TRANSFORMATEUR MIS A TERRE 12507</p>
---	--	---

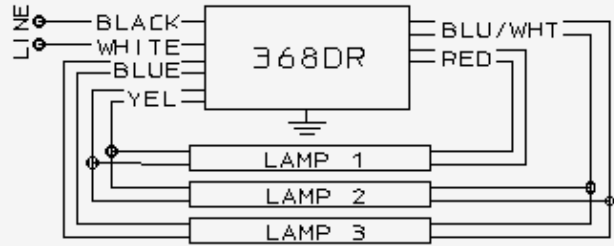
<p>CATALOG NO. 368DR</p> <p>120 Volts 60 Hz.</p> <p>MAX. LINE 2.0 AMPS OUTPUT 590 VOLTS HIGH POWER FACTOR</p> <p> LISTED 820G</p>	<p>FRANCE</p> <p>A SCOTT FETZER COMPANY</p> <p>FLUORESCENT LAMP BALLAST NON-FLASHING OUTDOOR TYPE 2 3 LAMPS - 12 TO 18 FEET</p> <p>FOR ANY 3 LAMP COMBINATION OF 800 mA T-12 H.O. RAPID START LAMPS. TOTAL FOOTAGE OF ALL LAMPS MUST NOT EXCEED 18 FT. NOR BE LESS THAN 12 FT.</p> <p>FAIRVIEW, TN 37062 MADE IN U.S.A.</p>	<p>DANGER HIGH VOLTAGE 590 OUTPUT VOLTS OPEN CIRCUIT OR TO GROUND DANGER HAUTE TENSION</p>  <p>MOUNT LAMPS WITHIN ONE INCH OF GROUNDED METAL STARTING AID. MIN. STARTING TEMP. -20°F (-30°C).</p> <p>GROUND BALLAST CASE</p> <p>NO PCB'S AUTO RESET THERMALLY PROTECTED CLASS P</p> <p>CAISSE DU TRANSFORMATEUR MIS A TERRE 12502</p>
---	--	--

France Ballast Labels

As of 07/27/2004

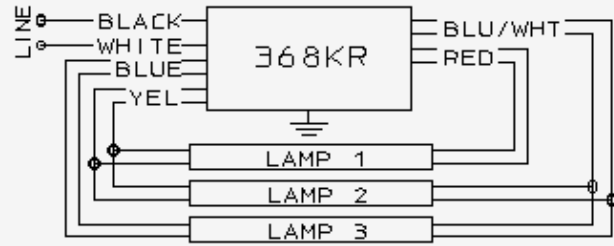
<p>CATALOG NO. 368KR</p> <p>277 Volts 60 Hz.</p> <p>MAX. LINE: 0.86AMPS OUTPUT: 590 VOLTS HIGH POWER FACTOR</p> <p> LISTED 820G</p>	<p>FRANCE A SCOTT FETZER COMPANY</p> <p>FLUORESCENT LAMP BALLAST NON-FLASHING OUTDOOR TYPE 2 <u>3 LAMPS - 8 TO 18 FEET</u></p> <p>FOR ANY 3 LAMP COMBINATION OF 800 mA T-12 H.O. RAPID START LAMPS. TOTAL FOOTAGE OF ALL LAMPS MUST NOT EXCEED 18 FT. NOR BE LESS THAN 8 FT.</p> <p>FAIRVIEW, TN 37062 MADE IN U.S.A.</p>	<p>DANGER HIGH VOLTAGE 590 OUTPUT VOLTS OPEN CIRCUIT OR TO GROUND DANGER HAUTE TENSION</p>  <p>MOUNT LAMPS WITHIN ONE INCH OF GROUNDED METAL STARTING AID. MIN. STARTING TEMP. -20°F (-30°C).</p> <p>GROUND BALLAST CASE CAISSE DU TRANSFORMATEUR MIS A TERRE</p> <p>NO PCB'S AUTO RESET THERMALLY PROTECTED CLASS P</p> <p>12504</p>
---	---	---

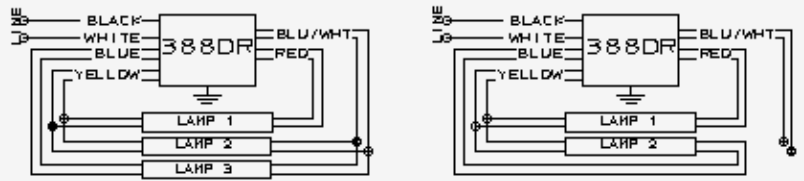
<p>CATALOG NO. 388DR</p> <p>120 Volts 60 Hz.</p> <p>MAX. LINE: 2.70 AMPS OUTPUT: 720 VOLTS HIGH POWER FACTOR</p> <p> LISTED 820G</p>	<p>FRANCE A SCOTT FETZER COMPANY</p> <p>FLUORESCENT LAMP BALLAST NON-FLASHING OUTDOOR TYPE 2 <u>2 OR 3 LAMPS - 16 TO 24 FEET</u></p> <p>FOR ANY 2 OR 3 LAMP COMBINATION OF 800mA T-12 H.O. RAPID START LAMPS. TOTAL FOOTAGE OF ALL LAMPS MUST NOT EXCEED 24 FT. NOR BE LESS THAN 16 FT.</p> <p>FAIRVIEW, TN 37062 MADE IN U.S.A.</p>	<p>DANGER HIGH VOLTAGE 720 OUTPUT VOLTS 600 VOLTS TO GROUND. DANGER HAUTE TENSION</p>  <p>INSULATE EACH UNUSED LEAD FROM GROUND AND ALL OTHER LEADS. MOUNT LAMPS WITHIN ONE INCH OF GROUNDED METAL STARTING AID. MIN STARTING TEMP. -20°F (-30°C).</p> <p>GROUND BALLAST CASE CAISSE DU TRANSFORMATEUR MIS A TERRE</p> <p>NO PCB'S AUTO RESET THERMALLY PROTECTED CLASS P</p> <p>12309</p>
--	--	--

France Ballast Labels

As of 07/27/2004

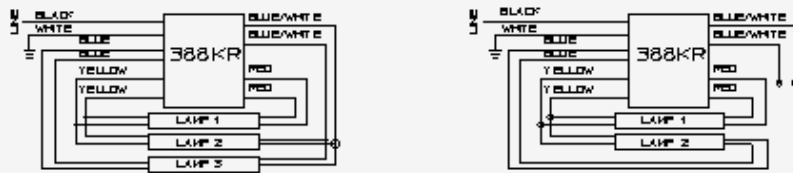
<p>CATALOG NO. 388KR</p> <p>277 Volts 60 Hz.</p> <p>MAX. LINE: 1.1 AMPS OUTPUT: 720 VOLTS HIGH POWER FACTOR</p>  <p>LISTED 8206</p>	<p>FRANCE A Scott Fetzer Company</p> <p>FLUORESCENT LAMP BALLAST NON-FLASHING OUTDOOR TYPE 2 2 OR 3 LAMPS - 16 TO 24 FEET</p> <p>FOR ANY 2 OR 3 LAMP COMBINATION OF 800mA T-12 H.O. RAPID START LAMPS, TOTAL FOOTAGE OF ALL LAMPS MUST NOT EXCEED 24 FT. NOR BE LESS THAN 16 FT.</p> <p>FAIRVIEW, TN 37062 MADE IN U.S.A.</p>	<p>DANGER HIGH VOLTAGE 720 OUTPUT VOLTS 600 VOLTS TO GROUND. DANGER HAUTE TENSION</p>  <p>INSULATE EACH UNUSED LEAD FROM GROUND AND ALL OTHER LEADS. MOUNT LAMPS WITHIN ONE INCH OF GROUNDED METAL STARTING AID. MIN STARTING TEMP. -20°F (-30°C). GROUND BALLAST CASE CAISSE DU TRANSFORMATEUR MIS A TERRE</p> <p>NO PCB'S AUTO RESET THERMALLY PROTECTED CLASS P</p> <p>12310</p>
--	---	--

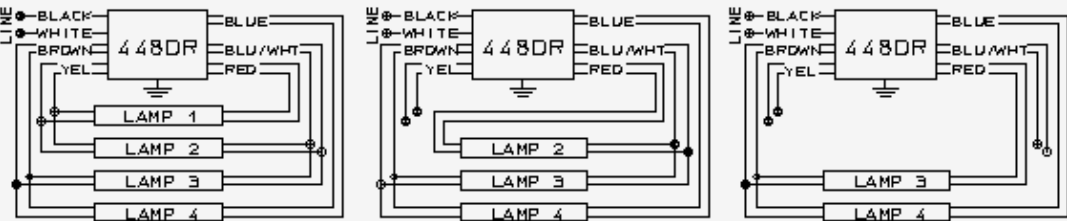
<p>CATALOG NO. 448DR</p> <p>120 Volts 60 Hz.</p> <p>MAX. LINE: 2.0 AMPS OUTPUT: 550 VOLTS HIGH POWER FACTOR</p>  <p>LISTED 8206</p>	<p>FRANCE A SCOTT FETZER COMPANY</p> <p>FLUORESCENT LAMP BALLAST NON-FLASHING OUTDOOR TYPE 2 2, 3 OR 4 LAMPS - 6 TO 16 FEET</p> <p>FOR ANY 2, 3 OR 4 LAMP COMBINATION OF 800mA T-12 H.O. RAPID START LAMPS, TOTAL FOOTAGE OF ALL LAMPS MUST NOT EXCEED 16 FT. NOR BE LESS THAN 6 FT.</p> <p>FAIRVIEW, TN 37062 MADE IN U.S.A.</p>	<p>DANGER HIGH VOLTAGE 550 OUTPUT VOLTS OPEN CIRCUIT OR TO GROUND DANGER HAUTE TENSION</p>  <p>INSULATE EACH UNUSED LEAD FROM GROUND AND ALL OTHER LEADS. MOUNT LAMPS WITHIN ONE INCH OF GROUNDED METAL STARTING AID. MIN STARTING TEMP. -20°F (-30°C). GROUND BALLAST CASE CAISSE DU TRANSFORMATEUR MIS A TERRE</p> <p>NO PCB'S AUTO RESET THERMALLY PROTECTED CLASS P</p> <p>12364</p>
---	---	--

France Ballast Labels

As of 07/27/2004

<p>CATALOG NO. 448KR</p> <p>277 Volts 60 Hz.</p> <p>MAX. LINE: 0.8 AMPS OUTPUT: 550 VOLTS HIGH POWER FACTOR</p>  LISTED 820G	<p>FRANCE A SCOTT FETZER COMPANY</p> <p>FLUORESCENT LAMP BALLAST NON-FLASHING OUTDOOR TYPE 2</p> <p>2, 3 OR 4 LAMPS - 6 TO 16 FEET</p> <p>FOR ANY 2, 3 OR 4 LAMP COMBINATON OF 800mA T-12 H.O. RAPID START LAMPS. TOTAL FOOTAGE OF ALL LAMPS MUST NOT EXCEED 16 FT. NOR BE LESS THAN 6 FT.</p> <p>FAIRVIEW, TN 37062 MADE IN U.S.A.</p>	<p>DANGER HIGH VOLTAGE 550 OUTPUT VOLTS OPEN CIRCUIT OR TO GROUND DANGER HAUTE TENSION</p> <p>INSULATE EACH UNUSED LEAD FROM GROUND AND ALL OTHER LEADS. MOUNT LAMPS WITHIN ONE INCH OF GROUNDED METAL STARTING AID. MIN STARTING TEMP. -20°F (-30°C). GROUND BALLAST CASE CAISSE DU TRANSFORMATEUR MIS A TERRE</p> <p>NO PCB'S AUTO RESET THERMALLY PROTECTED CLASS P</p> <p>12356</p>
--	---	---

<p>CATALOG NO. 458DR</p> <p>120 Volts 60 Hz.</p> <p>MAX. LINE: 2.3 AMPS OUTPUT: 590 VOLTS HIGH POWER FACTOR</p>  LISTED 820G	<p>FRANCE A SCOTT FETZER COMPANY</p> <p>FLUORESCENT LAMP BALLAST NON-FLASHING OUTDOOR TYPE 2</p> <p>2, 3 OR 4 LAMPS 8 TO 20 FEET</p> <p>FOR ANY FOUR LAMP COMBINATION OF 800 mA T-12 H.O. RAPID START LAMPS FROM 8 FT. TO 20 FT. TOTAL FOOTAGE. FOR ANY 2 OR 3 LAMP COMBINATION OF 800 mA T-12 H.O. RAPID START LAMPS FROM 8 FT. TO 18 FT. TOTAL FOOTAGE.</p> <p>FAIRVIEW, TN 37062 MADE U.S.A.</p>	<p>DANGER HIGH VOLTAGE 590 OUTPUT VOLTS OPEN CIRCUIT OR TO GROUND. DANGER HAUTE TENSION</p> <p>INSULATE EACH UNUSED LEAD FROM GROUND AND ALL OTHER LEADS. MOUNT LAMPS WITHIN ONE INCH OF GROUNDED METAL STARTING AID. MIN STARTING TEMP. -20°F (-30°C). GROUND BALLAST CASE CAISSE DU TRANSFORMATEUR MIS A TERRE</p> <p>NO PCB'S AUTO RESET THERMALLY PROTECTED CLASS P</p> <p>12497</p>
---	---	--

<p>CATALOG NO. 458KR</p> <p>277 Volts 60 Hz.</p> <p>MAX. LINE: 0.95 AMPS OUTPUT: 590 VOLTS HIGH POWER FACTOR</p>  LISTED 820G	<p>FRANCE A SCOTT FETZER COMPANY</p> <p>FLUORESCENT LAMP BALLAST NON-FLASHING OUTDOOR TYPE 2</p> <p>2, 3 OR 4+ LAMPS 8 TO 18 FEET</p> <p>FOR ANY 1, 2, 3, OR 4+ LAMP COMBINATION 800 mA T-12 H.O. RAPID START LAMPS TOTAL FOOTAGE OF ALL LAMPS MUST NOT EXCEED 18 FT. NOR BE LESS THAN 8 FT. + TOTAL FOOTAGE FOR 4 LAMP COMBINATION MUST NOT EXCEED 20 FEET.</p> <p>FAIRVIEW, TN 37062 MADE U.S.A.</p>	<p>DANGER HIGH VOLTAGE 590 OUTPUT VOLTS OPEN CIRCUIT OR TO GROUND. DANGER HAUTE TENSION</p> <p>INSULATE EACH UNUSED LEAD FROM GROUND AND ALL OTHER LEADS. MOUNT LAMPS WITHIN ONE INCH OF GROUNDED METAL STARTING AID. MIN STARTING TEMP. -20°F (-30°C). GROUND BALLAST CASE CAISSE DU TRANSFORMATEUR MIS A TERRE</p> <p>NO PCB'S AUTO RESET THERMALLY PROTECTED CLASS P</p> <p>12508</p>
---	--	--

France Ballast Labels

As of 07/27/2004

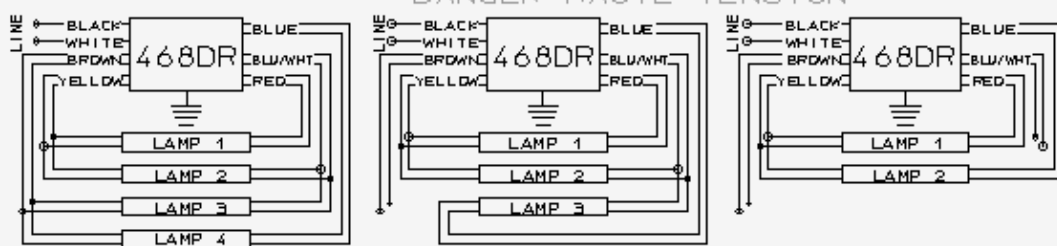
<p>CATALOG NO. 468DR</p> <p>120 Volts 60 Hz.</p> <p>MAX. LINE: 2.8 AMPS OUTPUT: 720 VOLTS HIGH POWER FACTOR</p> 	<p>FRANCE A SCOTT FETZER COMPANY</p> <p>FLUORESCENT LAMP BALLAST NON-FLASHING OUTDOOR TYPE 2 2,3 OR 4 LAMPS - 16 TO 24 FEET</p> <p>FDR ANY 2, 3, DR 4 LAMP COMBINATION OF 300mA T-12 H.D. RAPID START LAMPS. TOTAL FOOTAGE OF ALL LAMPS MUST NOT EXCEED 24 FT. NOR BE LESS THAN 16 FT.</p> <p>FAIRVIEW, TN 37062</p>	<p style="text-align: center;">DANGER HIGH VOLTAGE 720 OUTPUT VOLTS 600 VOLTS TO GROUND. DANGER HAUTE TENSION</p>  <p style="text-align: center;">INSULATE EACH UNUSED LEAD FROM GROUND AND ALL OTHER LEADS. MOUNT LAMPS WITHIN ONE INCH OF GROUNDED METAL STARTING AID. MIN STARTING TEMP. -20°F (-30°C). GROUND BALLAST CASE CAISSE DU TRANSFORMATEUR MIS A TERRE</p> <p style="text-align: right;">NO PCB'S AUTO RESET THERMALLY PROTECTED CLASS P</p> <p style="text-align: right;">10594</p>
--	---	--

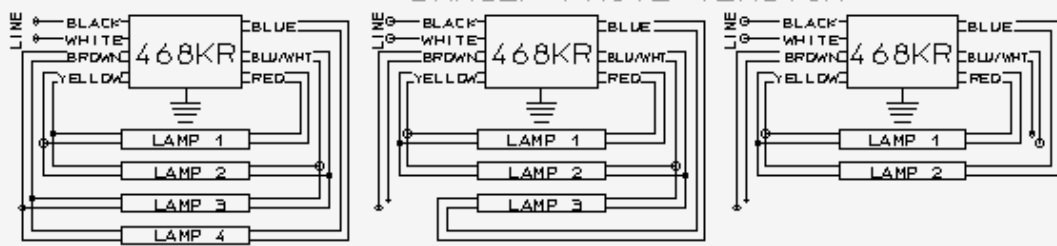
<p>CATALOG NO. 468KR</p> <p>277 Volts 60 Hz.</p> <p>MAX. LINE: 1.1 AMPS OUTPUT: 720 VOLTS HIGH POWER FACTOR</p> 	<p>FRANCE A SCOTT FETZER COMPANY</p> <p>FLUORESCENT LAMP BALLAST NON-FLASHING OUTDOOR TYPE 2 2,3 OR 4 LAMPS - 16 TO 24 FEET</p> <p>FDR ANY 2, 3, DR 4 LAMP COMBINATION OF 300mA T-12 H.D. RAPID START LAMPS. TOTAL FOOTAGE OF ALL LAMPS MUST NOT EXCEED 24 FT. NOR BE LESS THAN 16 FT.</p> <p>FAIRVIEW, TN 37062</p>	<p style="text-align: center;">DANGER HIGH VOLTAGE 720 OUTPUT VOLTS 600 VOLTS TO GROUND. DANGER HAUTE TENSION</p>  <p style="text-align: center;">INSULATE EACH UNUSED LEAD FROM GROUND AND ALL OTHER LEADS. MOUNT LAMPS WITHIN ONE INCH OF GROUNDED METAL STARTING AID. MIN STARTING TEMP. -20°F (-30°C). GROUND BALLAST CASE CAISSE DU TRANSFORMATEUR MIS A TERRE</p> <p style="text-align: right;">NO PCB'S AUTO RESET THERMALLY PROTECTED CLASS P</p> <p style="text-align: right;">12357</p>
--	---	--

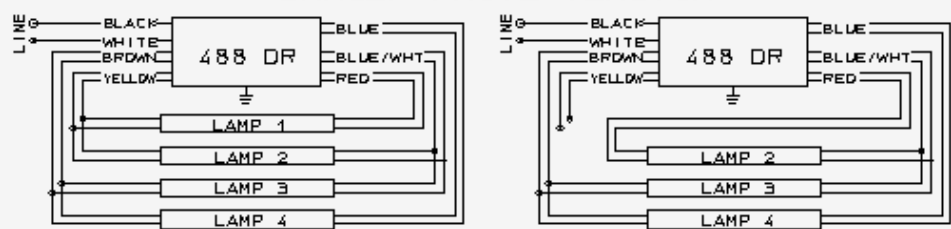
<p>CATALOG NO. 488DR</p> <p>120 Volts 60 Hz.</p> <p>MAX. LINE: 3.2 AMPS OUTPUT: 940 VOLTS HIGH POWER FACTOR</p> 	<p>FRANCE A SCOTT FETZER COMPANY</p> <p>FLUORESCENT LAMP BALLAST NON-FLASHING OUTDOOR TYPE 2 3 OR 4 LAMPS - 20 TO 32 FEET</p> <p>FOR ANY 3 OR 4 LAMP COMBINATION OF 300 mA T-12 H.O. RAPID START LAMPS. TOTAL FOOTAGE OF ALL LAMPS MUST NOT EXCEED 32 FT. NOR BE LESS THAN 20 FT.</p> <p>FAIRVIEW, TN 37062</p>	<p style="text-align: center;">DANGER HIGH VOLTAGE 940 OUTPUT VOLTS 600 VOLTS TO GROUND. DANGER HAUTE TENSION</p>  <p style="text-align: center;">INSULATE EACH UNUSED LEAD FROM GROUND AND ALL OTHER LEADS. MOUNT LAMPS WITHIN ONE INCH OF GROUNDED METAL STARTING AID. MIN STARTING TEMP. -20°F (-30°C). GROUND BALLAST CASE CAISSE DU TRANSFORMATEUR MIS A TERRE</p> <p style="text-align: right;">NO PCB'S AUTO RESET THERMALLY PROTECTED CLASS P</p> <p style="text-align: right;">12362</p>
--	--	--

France Ballast Labels

As of 07/27/2004

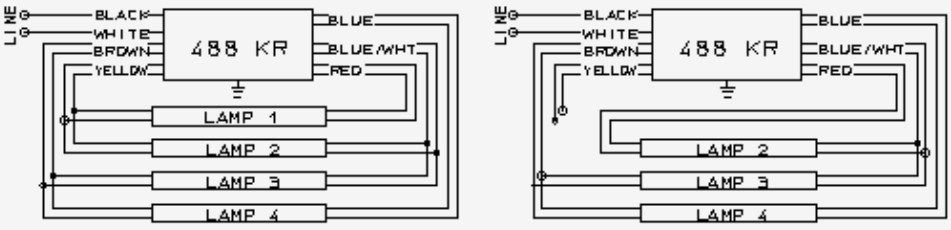
<p>CATALOG NO. 488KR</p> <p>277 Volts 60 Hz.</p> <p>MAX. LINE: 1.4 AMPS OUTPUT: 940 VOLTS HIGH POWER FACTOR</p>  <p>LISTED 8206</p>	<p>FRANCE A SCOTT FETZER COMPANY</p> <p>FLUORESCENT LAMP BALLAST NON-FLASHING OUTDOOR TYPE 2 3 OR 4 LAMPS - 20 TO 32 FEET</p> <p>FOR ANY 3 OR 4 LAMP COMBINATION OF 800 mA T-12 H.O. RAPID START LAMPS. TOTAL FOOTAGE OF ALL LAMPS MUST NOT EXCEED 32 FT. NOR BE LESS THAN 20 FT.</p> <p>FAIRVIEW, TN 37062 MADE IN U.S.A.</p>	<p>DANGER HIGH VOLTAGE 940 OUTPUT VOLTS 600 VOLTS TO GROUND. DANGER HAUTE TENSION</p>  <p>INSULATE EACH UNUSED LEAD FROM GROUND AND ALL OTHER LEADS. MOUNT LAMPS WITHIN ONE INCH OF GROUNDED METAL STARTING AID. MIN STARTING TEMP. -20°F (-30°C). GROUND BALLAST CASE CAISSE DU TRANSFORMATEUR MIS A TERRE</p> <p>NO PCB'S AUTO RESET THERMALLY PROTECTED CLASS P</p> <p>12358</p>
---	---	---

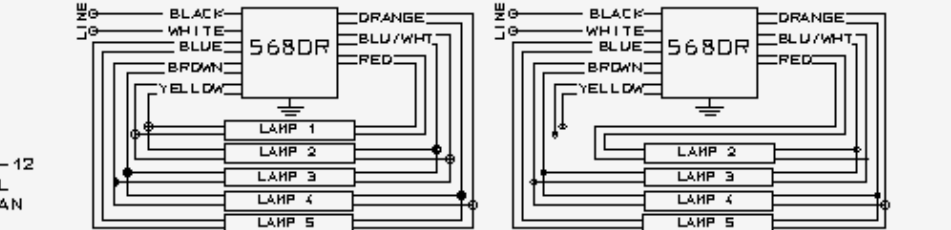
<p>CATALOG NO. 568DR</p> <p>120 Volts 60 Hz.</p> <p>MAX. LINE: 3.2 AMPS OUTPUT: 900 VOLTS HIGH POWER FACTOR</p>  <p>LISTED 8206</p>	<p>FRANCE A SCOTT FETZER COMPANY</p> <p>FLUORESCENT LAMP BALLAST NON-FLASHING OUTDOOR TYPE 2 4 OR 5 LAMPS - 20 TO 30 FEET</p> <p>FOR ANY 4 OR 5 LAMP COMBINATION OF 800 mA T-12 H.O. RAPID START LAMPS. TOTAL FOOTAGE OF ALL LAMPS MUST NOT EXCEED 30 FT. NOR BE LESS THAN 20 FT.</p> <p>FAIRVIEW, TN 37062 MADE IN USA</p>	<p>DANGER HIGH VOLTAGE 900 OUTPUT VOLTS 600 VOLTS TO GROUND. DANGER HAUTE TENSION</p>  <p>INSULATE EACH UNUSED LEAD FROM GROUND AND ALL OTHER LEADS. MOUNT LAMPS WITHIN ONE INCH OF GROUNDED METAL STARTING AID. MIN STARTING TEMP. -20°F (-30°C). GROUND BALLAST CASE CAISSE DU TRANSFORMATEUR MIS A TERRE</p> <p>NO PCB'S AUTO RESET THERMALLY PROTECTED CLASS P</p> <p>12499</p>
--	--	---

France Ballast Labels

As of 07/27/2004

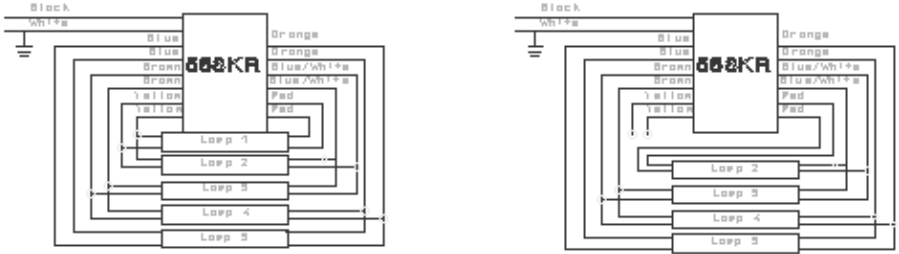
<p>CATALOG NO. 568KR</p> <p>277 Volts 60 Hz.</p> <p>MAX. LINE: 15 AMPS OUTPUT: 900 VOLTS HIGH POWER FACTOR</p> 	<p>FRANCE A SCOTT FETZER COMPANY</p> <p>FLUORESCENT LAMP BALLAST NON-FLASHING OUTDOOR TYPE 2 4 OR 5 LAMPS - 20 TO 30 FEET</p> <p>FOR ANY 4 OR 5 LAMP COMBINATION OF 800mA T-12 H.O. RAPID START LAMPS. TOTAL FOOTAGE OF ALL LAMPS MUST NOT EXCEED 30 FT. NOR BE LESS THAN 20 FT.</p> <p>FAIRVIEW, TN 37062 MADE IN U.S.A.</p>	<p style="text-align: center;">DANGER HIGH VOLTAGE 900 OUTPUT VOLTS 600 VOLTS TO GROUND. DANGER HAUTE TENSION</p>  <p style="text-align: center;">INSULATE EACH UNUSED LEAD FROM GROUND AND ALL OTHER LEADS. MOUNT LAMPS WITHIN ONE INCH OF GROUNDED METAL STARTING AID. MIN STARTING TEMP. -20°F (-30°C). GROUND BALLAST CASE Caisse du transformateur mis à terre</p> <p style="text-align: right;">NO PCB'S AUTO RESET THERMALLY PROTECTED CLASS P</p> <p style="text-align: right;">12496</p>
--	---	---

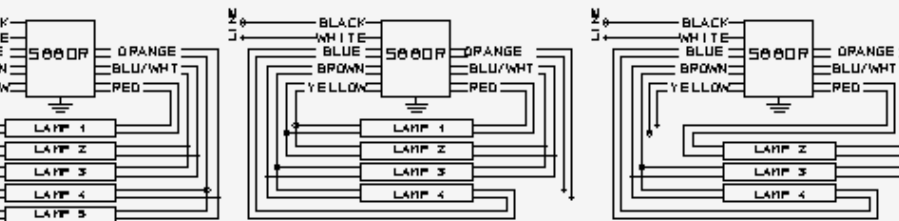
<p>CATALOG NO. 588DR</p> <p>120 Volts 60 Hz.</p> <p>MAX. LINE: 4.0 AMPS OUTPUT: 720 VOLTS HIGH POWER FACTOR</p> 	<p>FRANCE A SCOTT FETZER COMPANY</p> <p>FLUORESCENT LAMP BALLAST NON-FLASHING OUTDOOR TYPE 2 3, 4 OR 5 LAMPS - 16 TO 40 FEET</p> <p>FOR ANY 3, 4 OR 5 LAMP COMBINATION OF 800mA T-12 H.O. RAPID START LAMPS. FOOTAGE OF LAMPS 1 & 2 COMBINED MUST NOT EXCEED 16 FT. NOR BE LESS THAN 8 FT. FOOTAGE OF LAMPS 3, 4 & 5 COMBINED MUST NOT EXCEED 24 FT. NOR BE LESS THAN 8 FT. POWER FACTOR ABOVE 85% FOR FOOTAGE LESS THAN 20 FT.</p> <p>FAIRVIEW, TN 37062 MADE IN U.S.A.</p>	<p style="text-align: center;">DANGER HIGH VOLTAGE 720 OUTPUT VOLTS 600 VOLTS TO GROUND. DANGER HAUTE TENSION</p>  <p style="text-align: center;">INSULATE EACH UNUSED LEAD FROM GROUND AND ALL OTHER LEADS. MOUNT LAMPS WITHIN ONE INCH OF GROUNDED METAL STARTING AID. MIN STARTING TEMP. -20°F (-30°C). GROUND BALLAST CASE Caisse du transformateur mis à terre</p> <p style="text-align: right;">NO PCB'S AUTO RESET THERMALLY PROTECTED CLASS P</p> <p style="text-align: right;">12430</p>
--	--	---

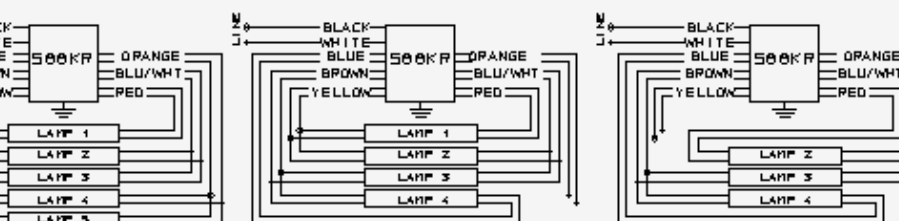
<p>CATALOG NO. 588KR</p> <p>277 Volts 60 Hz.</p> <p>MAX. LINE: 1.70 AMPS OUTPUT: 720 VOLTS HIGH POWER FACTOR</p> 	<p>FRANCE A SCOTT FETZER COMPANY</p> <p>FLUORESCENT LAMP BALLAST NON-FLASHING OUTDOOR TYPE 2 3, 4 OR 5 LAMPS - 16 TO 40 FEET</p> <p>FOR ANY 3, 4 OR 5 LAMP COMBINATION OF 800mA T-12 H.O. RAPID START LAMPS. FOOTAGE OF LAMPS 1 & 2 COMBINED MUST NOT EXCEED 16 FT. NOR BE LESS THAN 8 FT. FOOTAGE OF LAMPS 3, 4 & 5 COMBINED MUST NOT EXCEED 24 FT. NOR BE LESS THAN 8 FT.</p> <p>FAIRVIEW, TN 37062 MADE IN U.S.A.</p>	<p style="text-align: center;">DANGER HIGH VOLTAGE 720 OUTPUT VOLTS 600 VOLTS TO GROUND. DANGER HAUTE TENSION</p>  <p style="text-align: center;">INSULATE EACH UNUSED LEAD FROM GROUND AND ALL OTHER LEADS. MOUNT LAMPS WITHIN ONE INCH OF GROUNDED METAL STARTING AID. MIN STARTING TEMP. -20°F (-30°C). GROUND BALLAST CASE Caisse du transformateur mis à terre</p> <p style="text-align: right;">NO PCB'S AUTO RESET THERMALLY PROTECTED CLASS P</p> <p style="text-align: right;">12372</p>
--	--	---

France Ballast Labels

As of 07/27/2004

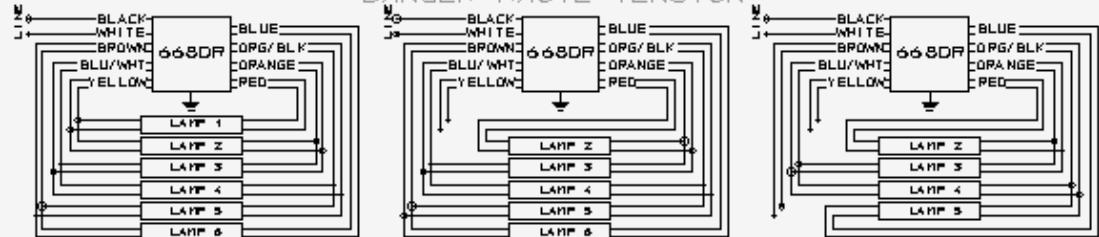
<p>CATALOG NO. 668DR</p> <p>120 Volts 60 Hz.</p> <p>MAX. LINE: 4.05 AMPS OUTPUT: 1000 VOLTS HIGH POWER FACTOR</p> 	<p>FRANCE A SCOTT FETZER COMPANY</p> <p>FLUORESCENT LAMP BALLAST NON-FLASHING OUTDOOR TYPE 2 4, 5 OR 6 LAMPS 24 TO 36 FEET</p> <p>FOR ANY 4.5 OR 6 LAMP COMBINATION OF 800mA T-12 H.D. RAPID START LAMPS FROM 24 FT. TO 36 FT. TOTAL FOOTAGE.</p> <p>FAIRVIEW, TN 37062 MADE IN U.S.A.</p>	<p style="text-align: center;">DANGER HIGH VOLTAGE 1000 OUTPUT VOLTS 600 VOLTS TO GROUND. DANGER HAUTE TENSION</p>  <p style="text-align: center;">INSULATE EACH UNUSED LEAD FROM GROUND AND ALL OTHER LEADS. MOUNT LAMPS WITHIN ONE INCH OF GROUNDED METAL STARTING AID. MIN STARTING TEMP. -20°F (-30°C). GROUND BALLAST CASE CAISSE DU TRANSFORMATEUR MIS A TERRE</p> <p style="text-align: right;">NO PCB'S AUTO RESET THERMALLY PROTECTED CLASS P</p> <p style="text-align: right;">12361</p>
--	---	--

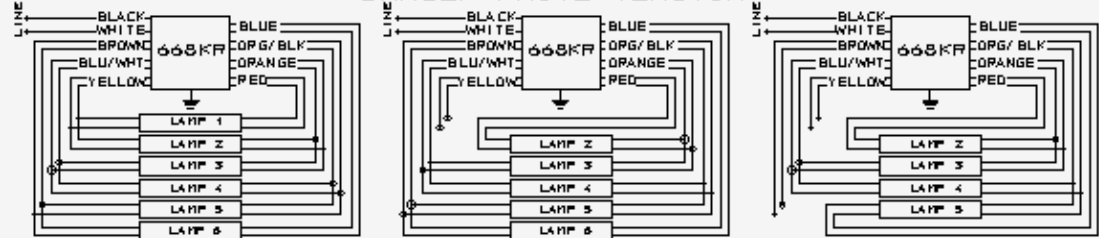
<p>CATALOG NO. 668KR</p> <p>277 Volts 60 Hz.</p> <p>MAX. LINE: 1.7 AMPS OUTPUT: 1000 VOLTS HIGH POWER FACTOR</p> 	<p>FRANCE A SCOTT FETZER COMPANY</p> <p>FLUORESCENT LAMP BALLAST NON-FLASHING OUTDOOR TYPE 2 4, 5 OR 6 LAMPS 24 TO 36 FEET</p> <p>FOR ANY 4.5 OR 6 LAMP COMBINATION OF 800mA T-12 H.D. RAPID START LAMPS FROM 24 FT. TO 36 FT. TOTAL FOOTAGE.</p> <p>FAIRVIEW, TN 37062 MADE IN U.S.A.</p>	<p style="text-align: center;">DANGER HIGH VOLTAGE 1000 OUTPUT VOLTS 600 VOLTS TO GROUND. DANGER HAUTE TENSION</p>  <p style="text-align: center;">INSULATE EACH UNUSED LEAD FROM GROUND AND ALL OTHER LEADS. MOUNT LAMPS WITHIN ONE INCH OF GROUNDED METAL STARTING AID. MIN STARTING TEMP. -20°F (-30°C). GROUND BALLAST CASE CAISSE DU TRANSFORMATEUR MIS A TERRE</p> <p style="text-align: right;">NO PCB'S AUTO RESET THERMALLY PROTECTED CLASS P</p> <p style="text-align: right;">12355</p>
---	---	--

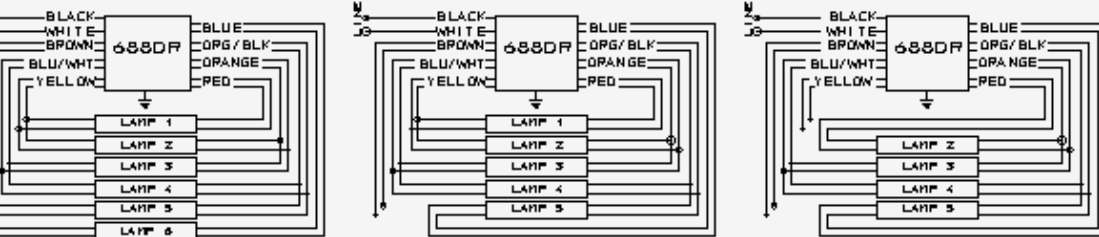
<p>CATALOG NO. 688DR</p> <p>120 Volts 60 Hz.</p> <p>MAX. LINE: 5.0 AMPS OUTPUT: 720 VOLTS HIGH POWER FACTOR</p> 	<p>FRANCE A SCOTT FETZER COMPANY</p> <p>FLUORESCENT LAMP BALLAST NON-FLASHING OUTDOOR TYPE 2 4, 5 OR 6 LAMPS - 36 TO 48 FEET</p> <p>FOR ANY 4.5 OR 6 LAMP COMBINATION OF 800mA T-12 H.D. RAPID START LAMPS FROM 36 FT. TO 48 FT. TOTAL FOOTAGE. COMBINED FOOTAGE OF LAMPS 1, 2, AND 3 OR LAMPS 4, 5, AND 6 MUST NOT EXCEED 24 FT. NOR BE LESS THAN 18 FT.</p> <p>FAIRVIEW, TN 37062 MADE IN U.S.A.</p>	<p style="text-align: center;">DANGER HIGH VOLTAGE 720 OUTPUT VOLTS 600 VOLTS TO GROUND. DANGER HAUTE TENSION</p>  <p style="text-align: center;">INSULATE EACH UNUSED LEAD FROM GROUND AND ALL OTHER LEADS. MOUNT LAMPS WITHIN ONE INCH OF GROUNDED METAL STARTING AID. MIN STARTING TEMP. -20°F (-30°C). GROUND BALLAST CASE CAISSE DU TRANSFORMATEUR MIS A TERRE</p> <p style="text-align: right;">NO PCB'S AUTO RESET THERMALLY PROTECTED CLASS P</p> <p style="text-align: right;">12360</p>
--	---	---

France Ballast Labels

As of 07/27/2004

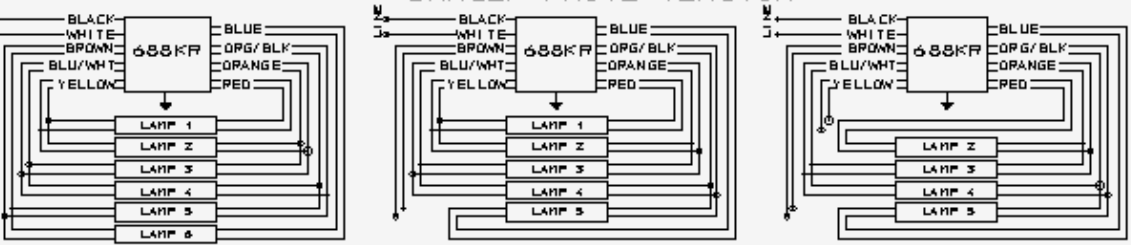
<p>CATALOG NO. 688KR</p> <p>277 Volts 60 Hz.</p> <p>MAX. LINE 1.75 AMPS OUTPUT 720 VOLTS HIGH POWER FACTOR</p>  <p>LISTED 620G</p>	<p>FRANCE A SCOTT FETZER COMPANY</p> <p>FLUORESCENT LAMP BALLAST NON-FLASHING OUTDOOR TYPE 2 4, 5 OR 6 LAMPS - 36 TO 48 FEET</p> <p>FOR ANY 4, 5 OR 6 LAMP COMBINATION OF 800mA T-12 H.O. RAPID START LAMPS FROM 36 FT. TO 48 FT. TOTAL FOOTAGE. COMBINED FOOTAGE OF LAMPS 1, 2, AND 3 OR LAMPS 4, 5, AND 6 MUST NOT EXCEED 24 FT. NOR BE LESS THAN 18 FT.</p> <p>FAIRVIEW, TN 37062 MADE IN U.S.A.</p>	<p style="text-align: center;">DANGER HIGH VOLTAGE 720 OUTPUT VOLTS 600 VOLTS TO GROUND. DANGER HAUTE TENSION</p>  <p style="text-align: center;">INSULATE EACH UNUSED LEAD FROM GROUND AND ALL OTHER LEADS. MOUNT LAMPS WITHIN ONE INCH OF GROUNDED METAL STARTING AID. MIN STARTING TEMP. -20°F (-30°C). GROUND BALLAST CASE CAISSE DU TRANSFORMATEUR MIS A TERRE</p> <p style="text-align: right;">NO PCB'S AUTO. RESET THERMALLY PROTECTED CLASS P</p> <p style="text-align: right;">12354</p>
--	---	--

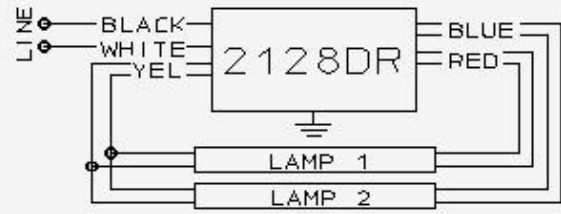
<p>CATALOG NO. 2128DR</p> <p>120 Volts 60 Hz.</p> <p>MAX. LINE 2.2 AMPS OUTPUT 720 VOLTS HIGH POWER FACTOR</p>  <p>LISTED 620G</p>	<p>FRANCE A SCOTT FETZER COMPANY</p> <p>FLUORESCENT LAMP BALLAST NON-FLASHING OUTDOOR TYPE 2 2 LAMPS - 16 TO 24 FEET</p> <p>FOR ANY 2 LAMP COMBINATION OF 800 mA T-12 H.O. RAPID START LAMPS. TOTAL FOOTAGE OF BOTH LAMPS MUST NOT EXCEED 24 FT. NOR BE LESS THAN 16 FT.</p> <p>FAIRVIEW, TN 37062 MADE IN U.S.A.</p>	<p style="text-align: center;">DANGER HIGH VOLTAGE 720 OUTPUT VOLTS 600 VOLTS TO GROUND. DANGER HAUTE TENSION</p>  <p style="text-align: center;">MOUNT LAMPS WITHIN ONE INCH OF GROUNDED METAL STARTING AID. MIN STARTING TEMP. -20°F (-30°C). GROUND BALLAST CASE CAISSE DU TRANSFORMATEUR MIS A TERRE</p> <p style="text-align: right;">NO PCB'S AUTO. RESET THERMALLY PROTECTED CLASS P</p> <p style="text-align: right;">12503</p>
---	---	--

France Ballast Labels

As of 07/27/2004

CATALOG NO.
2128KR

FRANCE

720 OUTPUT VOLTS 600 VOLTS TO GROUND.

277 Volts
60 Hz.

A SCOTT FETZER COMPANY

MAX. LINE .90AMPS
OUTPUT 720 VOLTS
HIGH POWER FACTOR

FLUORESCENT LAMP BALLAST
NON-FLASHING OUTDOOR TYPE 2
2 LAMPS - 16 TO 24 FEET

FOR ANY 2 LAMP COMBINATION OF 800 mA T-12
H.O. RAPID START LAMPS. TOTAL FOOTAGE OF
BOTH LAMPS MUST NOT EXCEED 24 FT. NOR BE
LESS THAN 16 FT.

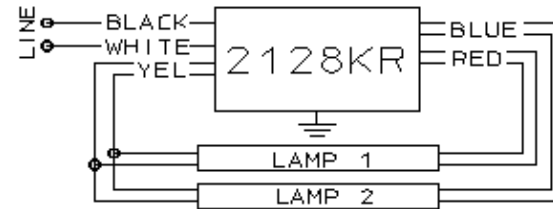

MOUNT LAMPS WITHIN ONE INCH
OF GROUNDED METAL STARTING AID.
MIN STARTING TEMP. -20°F (-30°C).

GROUND BALLAST CASE

CAISSE DU TRANSFORMATEUR MIS A TERRE 12505



FAIRVIEW, TN 37062

MADE IN U.S.A.

NO PCB'S
AUTO RESET
THERMALLY PROTECTED
CLASS P

CATALOG NO.
3128DR

FRANCE

DANGER HIGH VOLTAGE
1000 OUTPUT VOLTS 600 VOLTS TO GROUND
DANGER HAUTE TENSION

120 Volts
60 Hz.

A SCOTT FETZER COMPANY

MAX. LINE 3.6 AMPS
OUTPUT 1000 VOLTS
HIGH POWER FACTOR

FLUORESCENT LAMP BALLAST
NON-FLASHING OUTDOOR TYPE 2
3 LAMPS - 26 TO 36 FEET

FOR ANY 3 LAMP COMBINATION OF 800 mA T-12
H.O. RAPID START LAMPS. TOTAL FOOTAGE OF
ALL LAMPS MUST NOT EXCEED 36 FT. NOR BE
LESS THAN 26 FT.

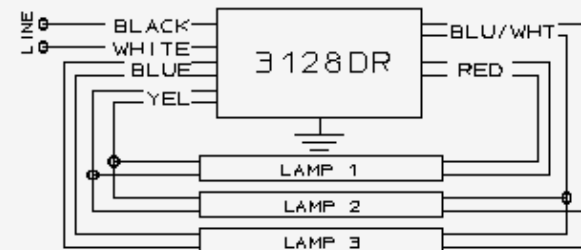

MOUNT LAMPS WITHIN ONE INCH
OF GROUNDED METAL STARTING AID.
MIN STARTING TEMP. -20°F (-30°C).

GROUND BALLAST CASE

CAISSE DU TRANSFORMATEUR MIS A TERRE 12501



FAIRVIEW, TN 37062

MADE IN U.S.A.

NO PCB'S
AUTO RESET
THERMALLY PROTECTED
CLASS P

France Ballast Labels

As of 07/27/2004

CATALOG NO.
4128DR

120 Volts
60 Hz.

MAX. LINE 3.9 AMPS
OUTPUT 720 VOLTS
HIGH POWER FACTOR



LISTED
820G

FRANCE

A SCOTT FETZER COMPANY

FLUORESCENT LAMP BALLAST
NON-FLASHING OUTDOOR TYPE 2
4 LAMPS - 36 TO 48 FEET

FOR ANY 4 LAMP COMBINATION OF 800 mA T-12
H.O. RAPID START LAMPS FROM 36 FT. TO 48 FT.
TOTAL FOOTAGE. FOOTAGE OF 1 & 2 COMBINED AND
FOOTAGE OF 3 & 4 COMBINED MUST NOT EXCEED 24
FT. NOR BE LESS THAN 18 FT.

FAIRVIEW, TN 37062

MADE IN U.S.A.

DANGER HIGH VOLTAGE
720 OUTPUT VOLTS 600 VOLTS TO GROUND
DANGER HAUTE TENSION

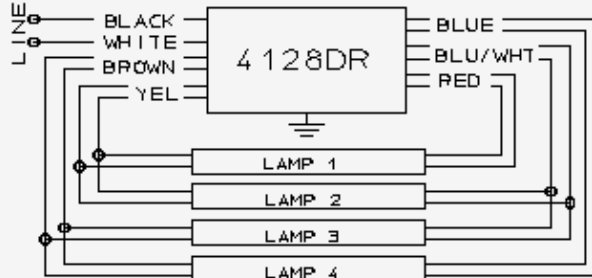

NO PCB'S
AUTO RESET
THERMALLY PROTECTED
CLASS P

GROUND BALLAST CASE
CAISSE DU TRANSFORMATEUR MIS A TERRE 12500

CATALOG NO.
4128KR

277 Volts
60 Hz.

MAX. LINE 1.7 AMPS
OUTPUT 720 VOLTS
HIGH POWER FACTOR



LISTED
820G

FRANCE

A SCOTT FETZER COMPANY

FLUORESCENT LAMP BALLAST
NON-FLASHING OUTDOOR TYPE 2
4 LAMPS - 36 TO 48 FEET

FOR ANY 4 LAMP COMBINATION OF 800 mA T-12
H.O. RAPID START LAMPS FROM 36 FT. TO 48 FT.
TOTAL FOOTAGE. FOOTAGE OF LAMPS 1 & 2 COMBINED
AND FOOTAGE OF LAMPS 3 & 4 COMBINED MUST NOT
EXCEED 24 FT. NOR BE LESS THAN 18 FT.

FAIRVIEW, TN 37062

MADE IN U.S.A.

DANGER HIGH VOLTAGE
720 OUTPUT VOLTS 600 VOLTS TO GROUND
DANGER HAUTE TENSION

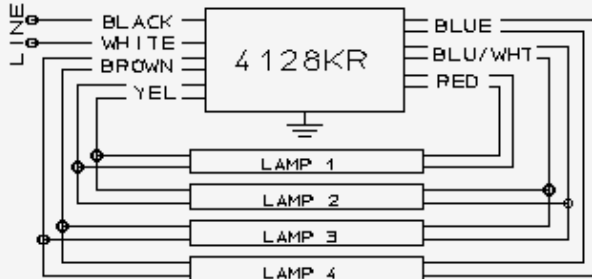

NO PCB'S
AUTO RESET
THERMALLY PROTECTED
CLASS P

GROUND BALLAST CASE
CAISSE DU TRANSFORMATEUR MIS A TERRE 12506